



ATTENZIONE: leggere

l'installazione deve essere eseguita da personale qualificato e abilitato;
 è necessario rispettare le norme e le disposizioni di legge in fatto di sicurezza;
 è necessario rispettare le disposizioni di installazione e manutenzione riportate sul presente manuale;
 le istruzioni costituiscono parte integrante del prodotto pertanto deve essere conservato;
 questo prodotto può essere destinato solo all'uso per il quale è stato progettato;

NON UTILIZZARE APPARECCHI ELETTRICI ALL'INTERNO DELLA CABINA

ATTENTION: read and follow all instructions

installation should be performed by qualified personnel;
 it is necessary to follow all security norms and laws;
 it is necessary to follow installation and maintenance instructions presented in this manual;
 the instructions form the integral part of the product and therefore they should be preserved;
 this product should be used with the scope for which it was developed.

DO NOT USE ELECTRICAL DEVICES INSIDE OF THE CABINE

**Kit accessori
Tools kit**

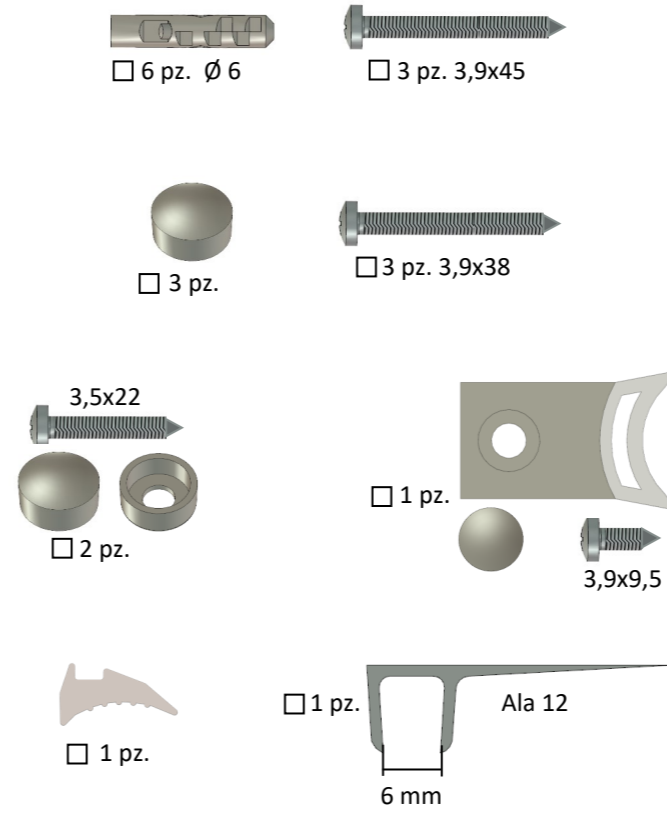

**Utensili per l'installazione
Tools for the installation**

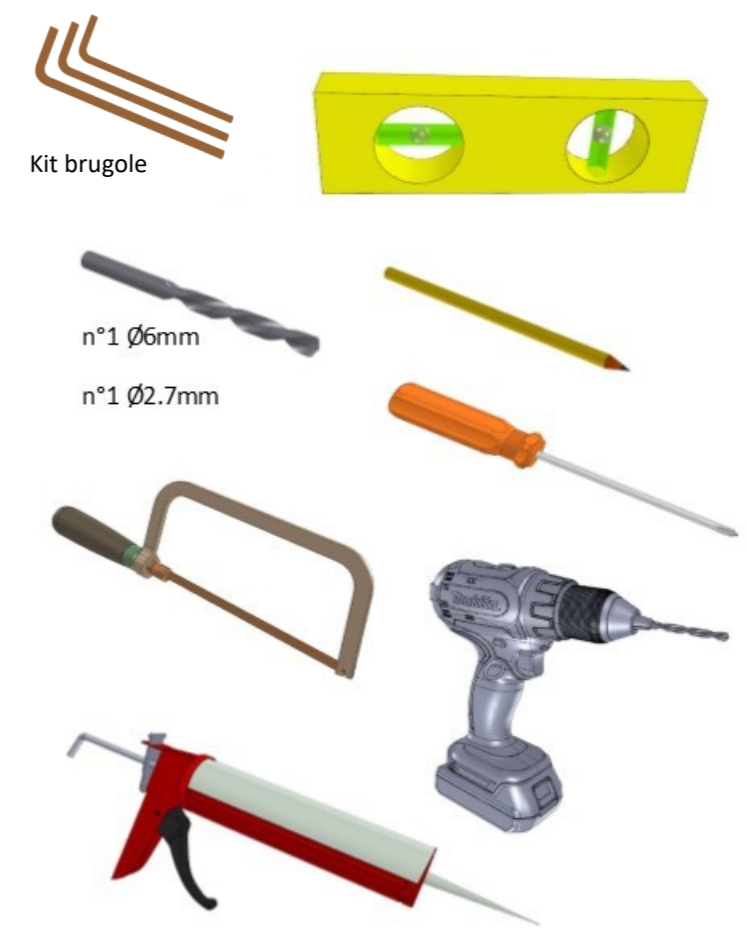

IMMAGINI INSERITE A SOLO SCOPO ILLUSTRATIVO
 IMAGES INSERTED FOR ILLUSTRATIVE PURPOSES ONLY

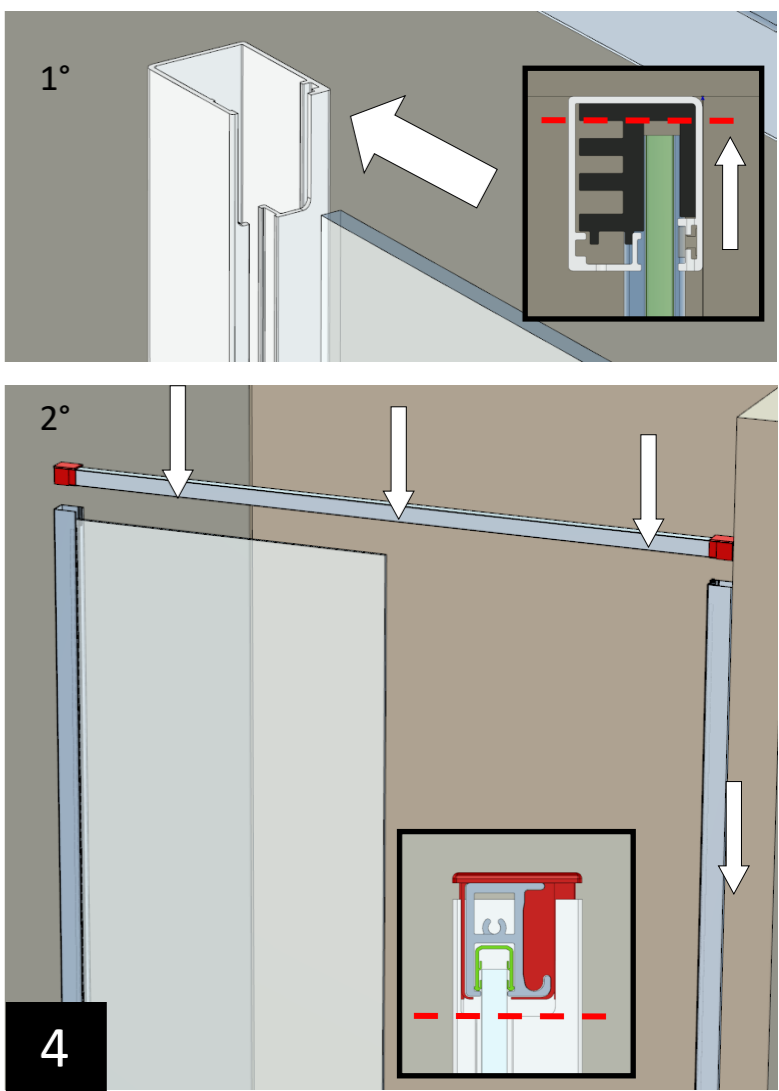
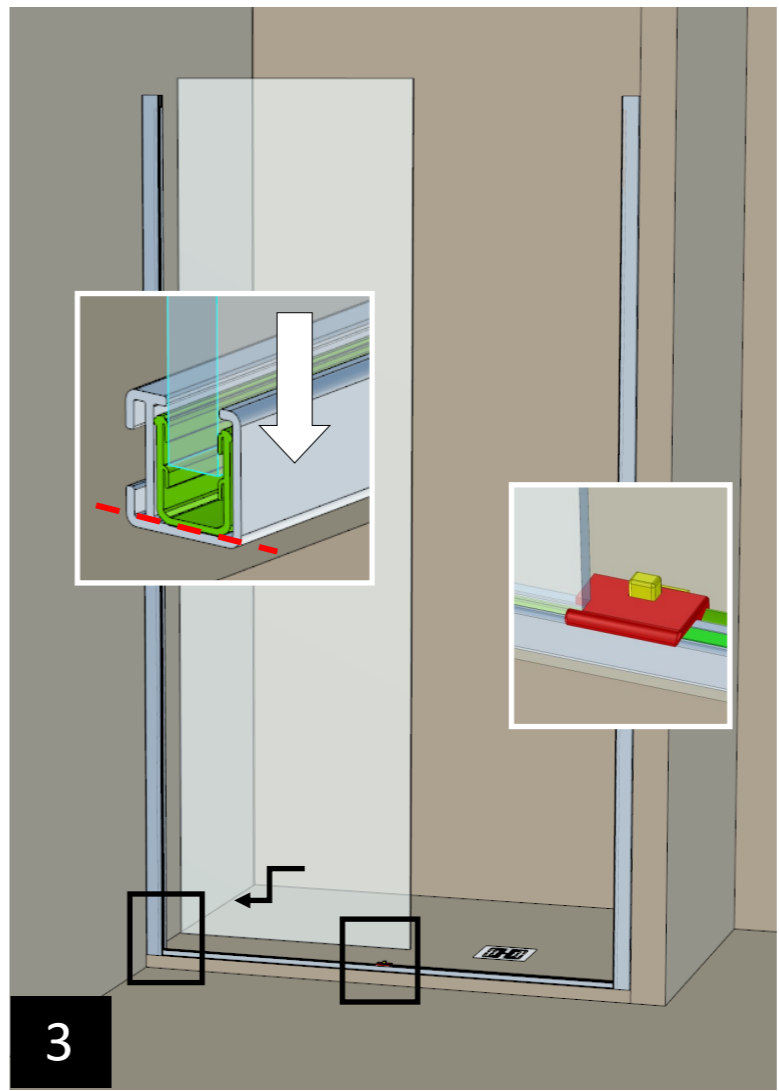
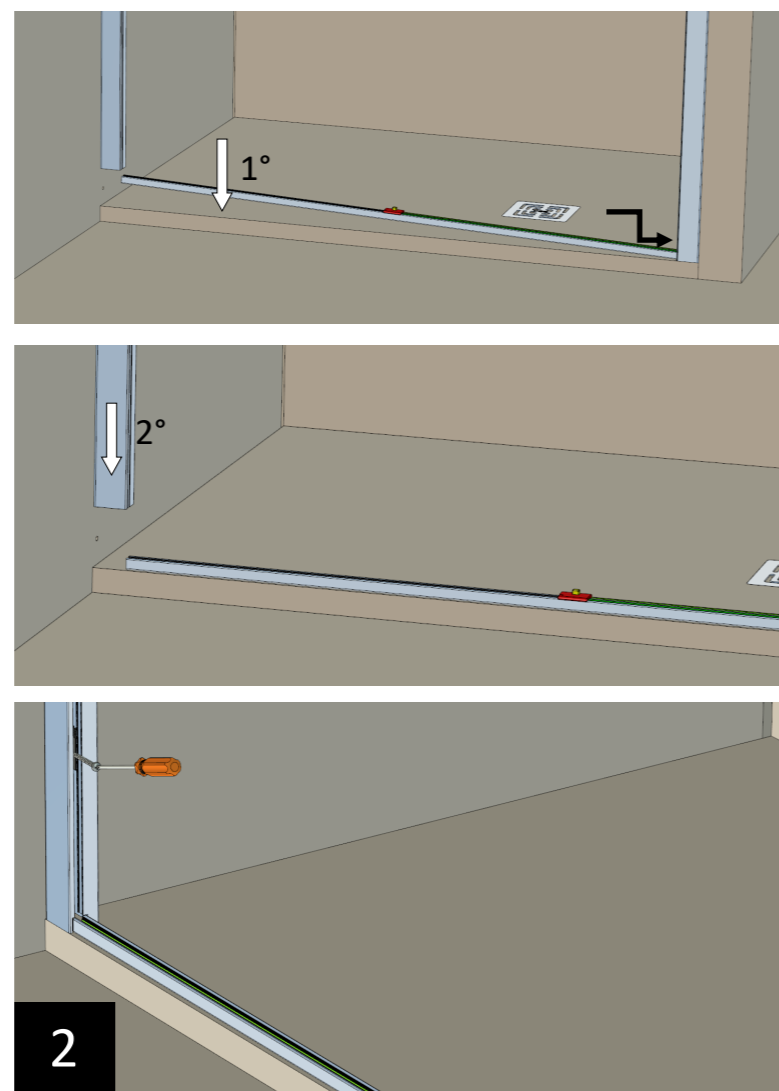
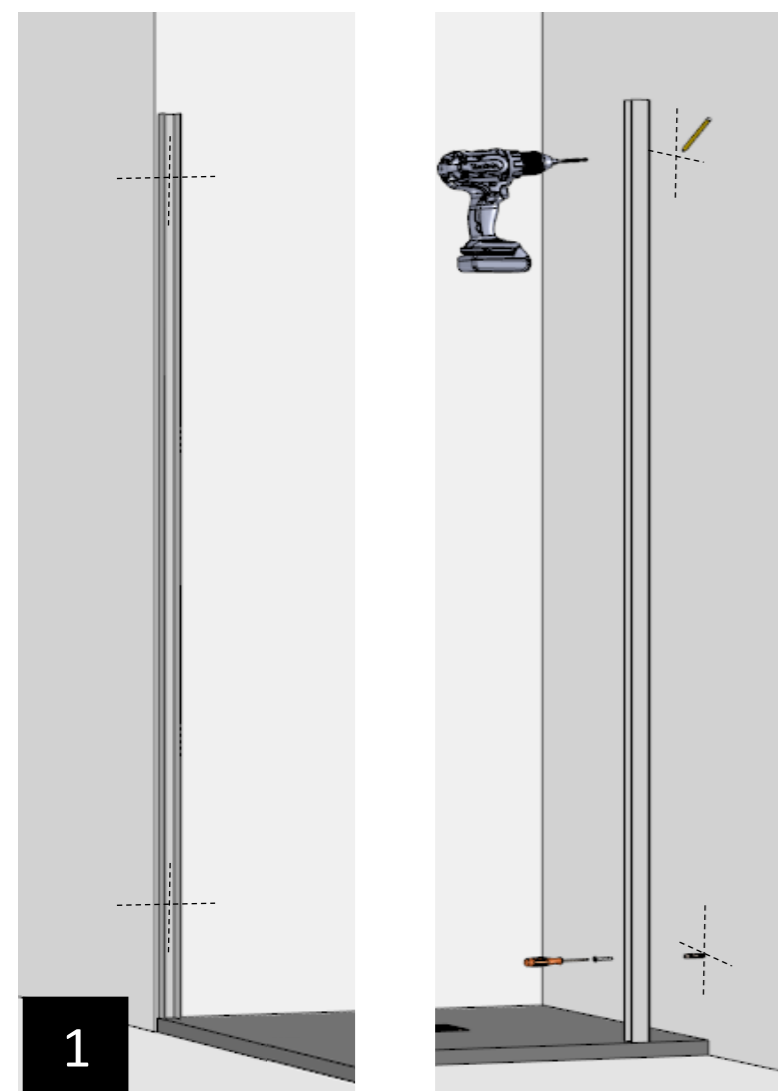

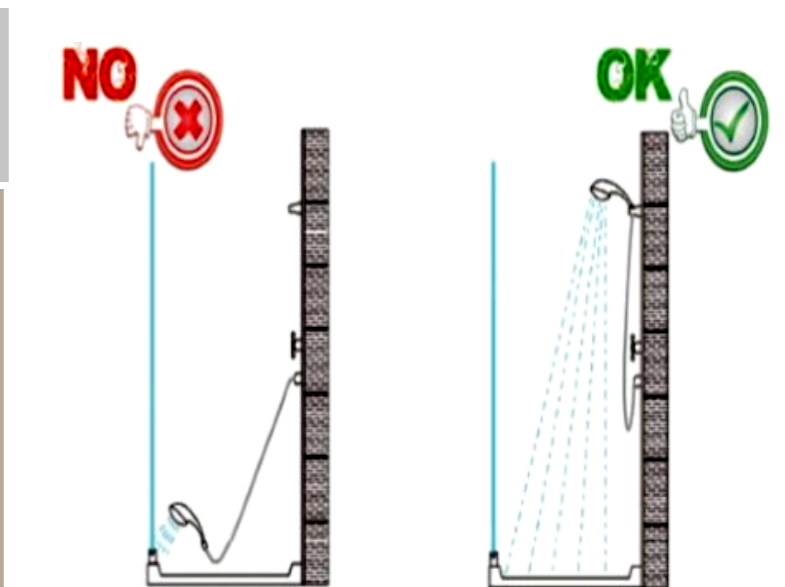
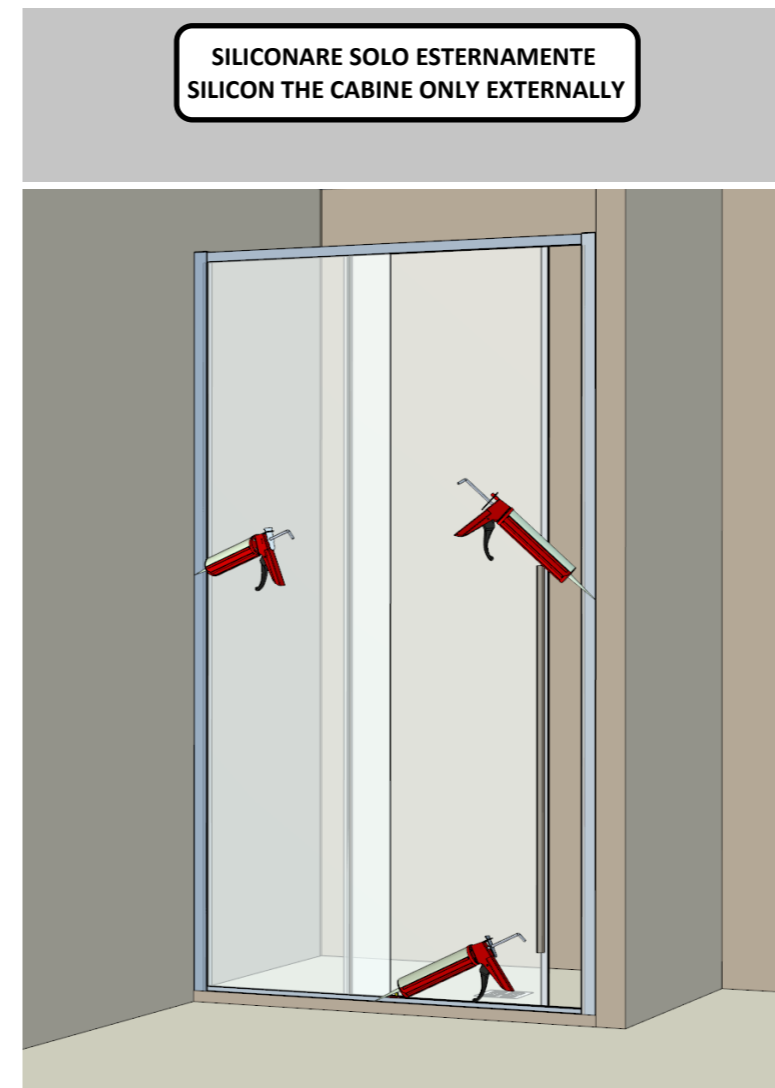
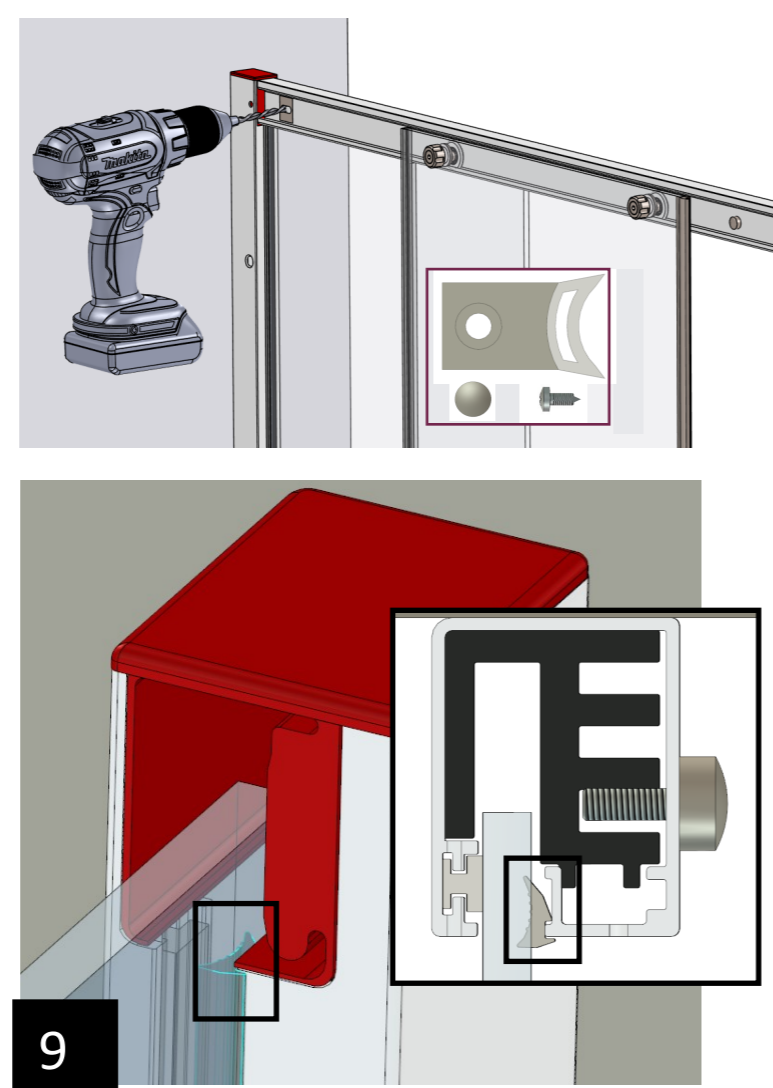
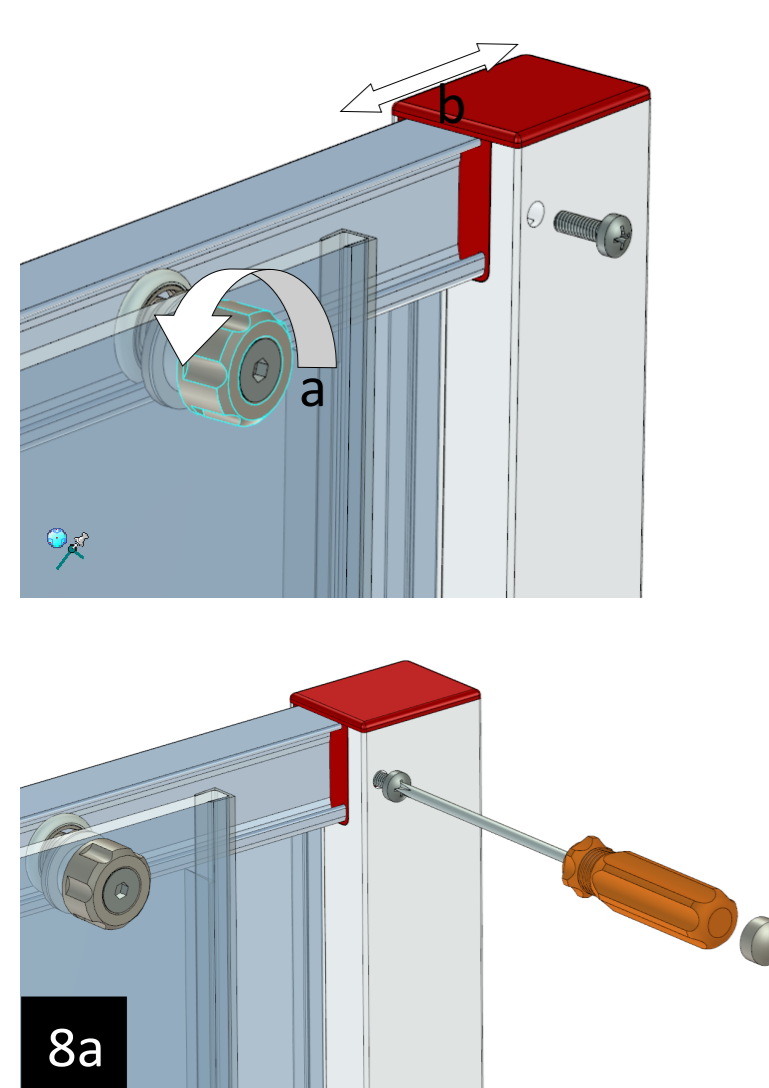
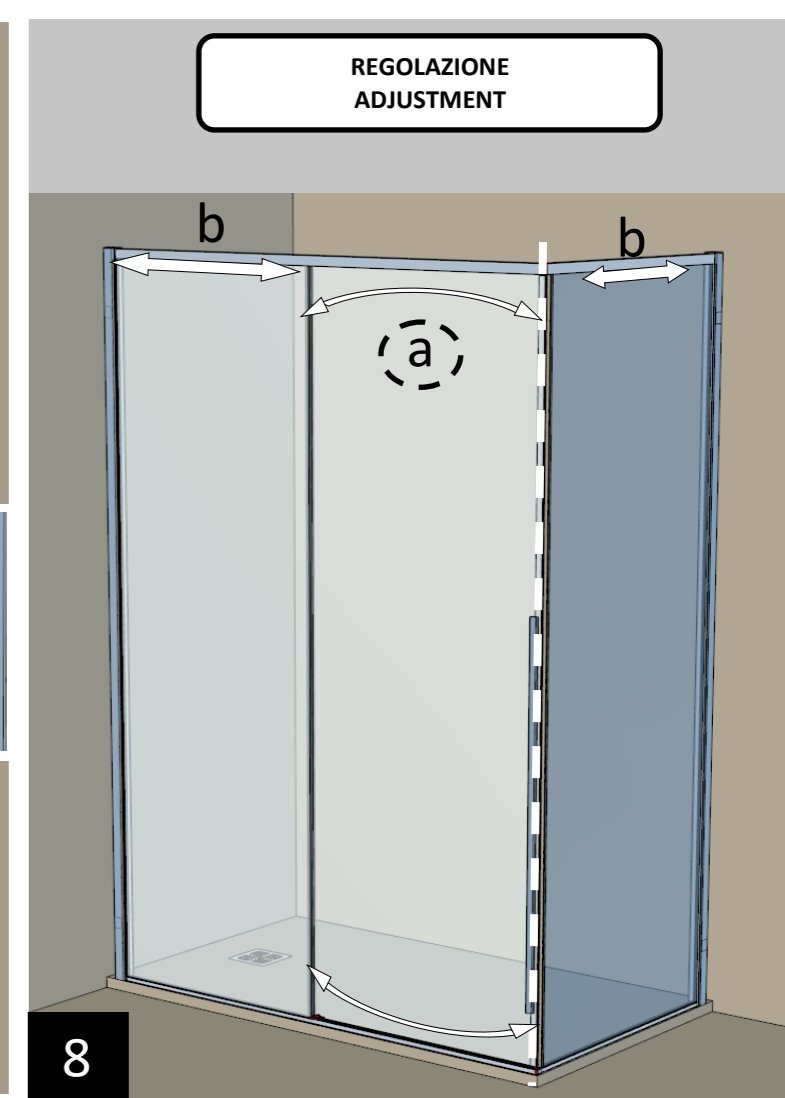
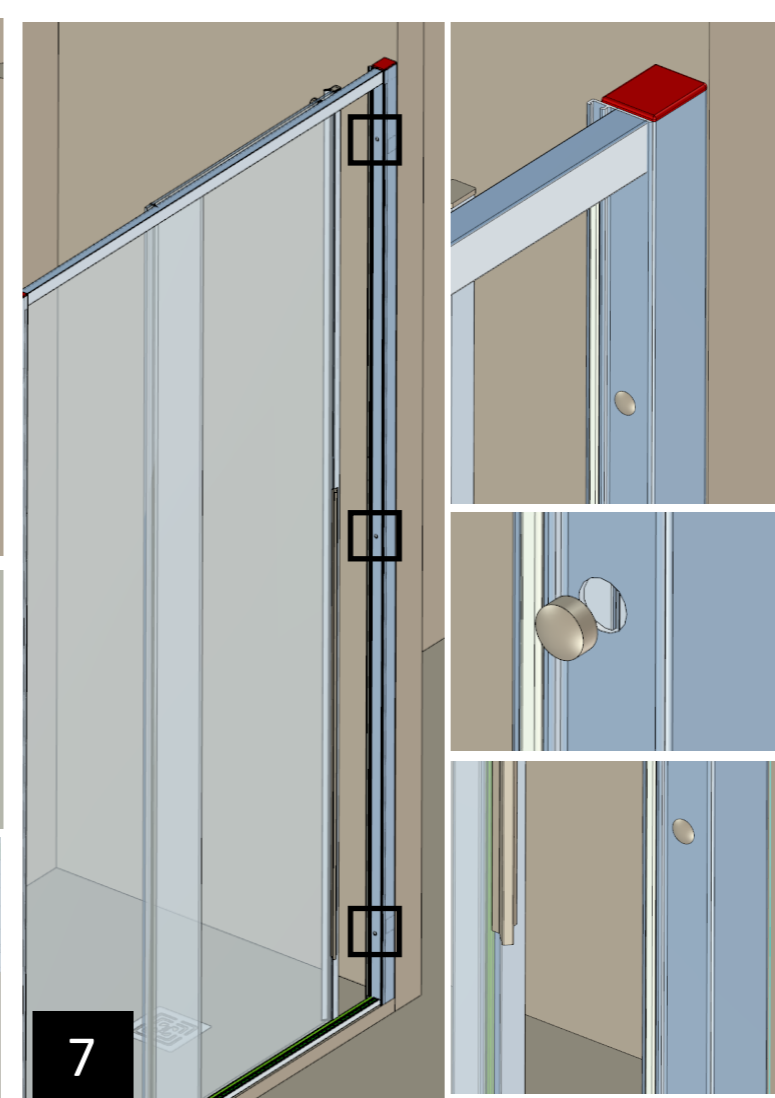
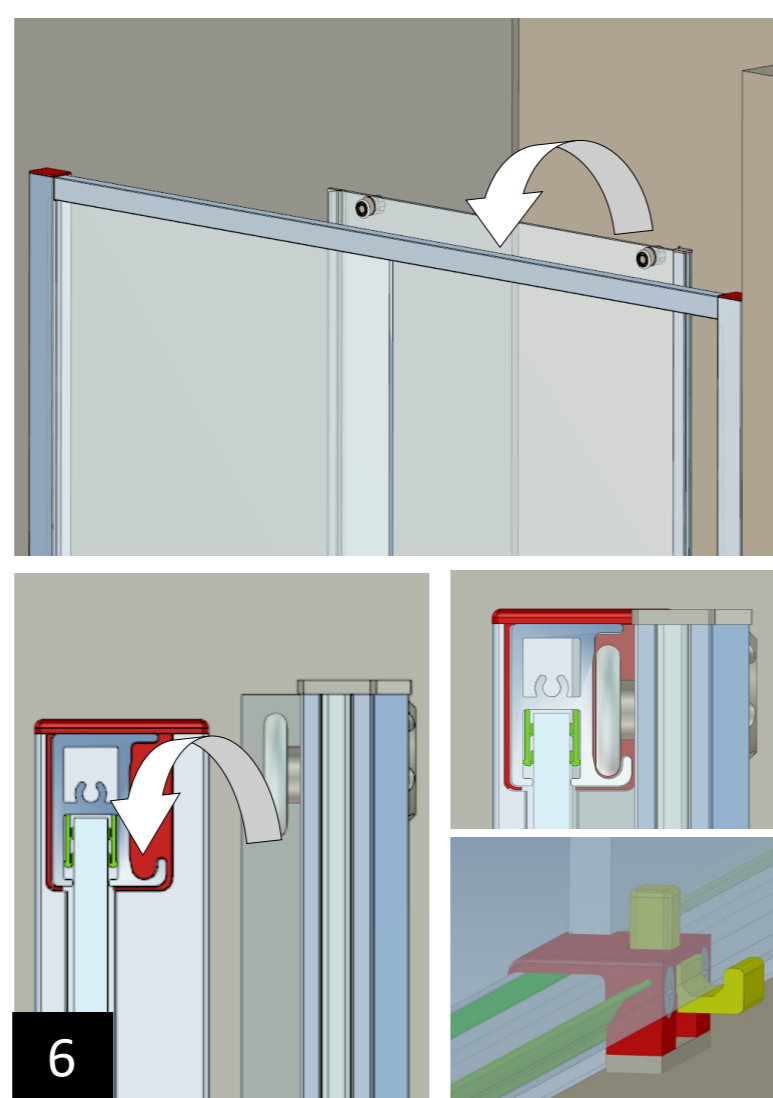
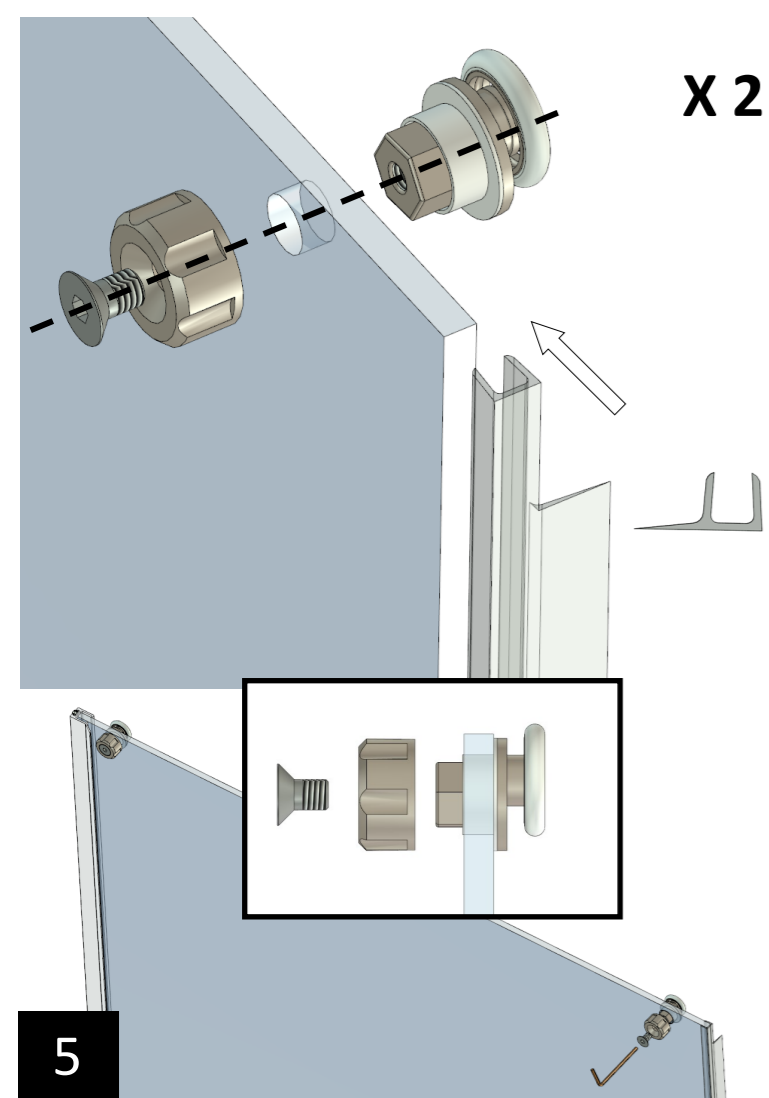

LA FUNZIONALITÀ DEL BOX DOCCIA
 Relativa alla tenuta dell'acqua è garantita soltanto se usata correttamente
 (come da disegno)

THE IMPERMEABILITY OF SHOWER CABINE
 is guaranteed only if it use correctly (as show in the picture)

CSA box doccia

IMPROVES YOUR LIFE

tel. +39 0112238545
 info@csaboxdoccia.it
 www.csaboxdoccia.it